

INT7 A/D CONVERTER

Clarity Hardware

ENG

Code/Rev.: M058/80E

Date: 2024-02-14

Phone: +420 251 013 400

clarity@dataapex.com

www.dataapex.com

DataApex Ltd.
Petrzilkova 2583/13
158 00 Prague 5
Czech Republic

Sections of the manual connected only to the **Clarity Full** version are marked with the  icon.

Clarity[®], DataApex[®] and [®] are trademarks of DataApex Ltd. Microsoft[®] and WindowsTM are trademarks of Microsoft Corporation.

DataApex reserves the right to make changes to manuals without prior notice. Updated manuals can be downloaded from www.dataapex.com.

Author: zte

Contents

1 INT7 Acquisition card	1
1.1 A/D Converter types in general	1
2 Requirements	3
3 Installation	4
3.1 The INT7	4
3.2 Standard cable for Clarity station	4
3.3 Connection with chromatograph	6
3.3.1 Connection of signal cables	6
3.3.2 Connection of starting cables	7
3.4 Clarity Configuration	8
3.4.1 Measuring on Multiple Instruments	10
3.4.2 Using multiple INT7 converters	10
4 Using the INT7 Card	12
4.1 DataApex INT7 Setup	12
4.2 Method Setup	15
4.2.1 Method Setup - Acquisition	15
4.2.2 Method Setup - Measurement	17
4.3 Digital Inputs and Outputs	18
4.4 Device Monitor	19
5 Troubleshooting	20
5.1 Locate your problem	20
5.2 Problems with INT7	21
5.2.1 How to check the INT7 driver	22
5.3 Manual Installation	24
5.3.1 Installation and reinstallation in Windows XP and later	24
5.3.2 Reinstallation of drivers using the System Restore Point	27
5.3.3 Reinstallation of drivers in Windows 2000	28
5.3.3.1 Deleting incorrect *.INF files in the system	28
5.3.3.2 Installing the correct driver manually	29
5.4 Data Acquisition - non-functional	32
5.5 Data Acquisition - Simulated	34
6 Tables and specifications	35
6.1 Description of the INT7 connector (Male)	35
6.2 Parameters of Digital Inputs and Outputs	36
6.3 INT7 - CE Conformity Declaration	37
6.4 Technical data	38

To facilitate the orientation in the **INT7 A/D Converter** manual and **Clarity** chromatography station, different fonts are used throughout the manual. Meanings of these fonts are:

Open File (italics) describes the commands and names of fields in **Clarity**, parameters that can be entered into them or a window or dialog name.

WORK1 (capitals) indicates the name of the file and/or directory.

ACTIVE (capital italics) marks the state of the station or its part.

Chromatogram (blue underlined) marks clickable links referring to related chapters.

The bold text is sometimes also used for important parts of the text and the name of the **Clarity** station. Moreover, some sections are written in format other than normal text. These sections are formatted as follows:

Note: Notifies the reader of relevant information.

Caution: Warns the user of possibly dangerous or very important information.

Marks the problem statement or trouble question.

Description: Presents more detailed information on the problem, describes its causes, etc.

Solution: Marks the response to the question, presents a procedure how to remove it.

1 INT7 Acquisition card

This manual describes the use of the **INT7 A/D Converter** with the **Clarity** software ver. **2.7 and later**.

INT7 is an internal 24-bit A/D converter card that measures the voltages of chromatographic and electrochemical detectors.

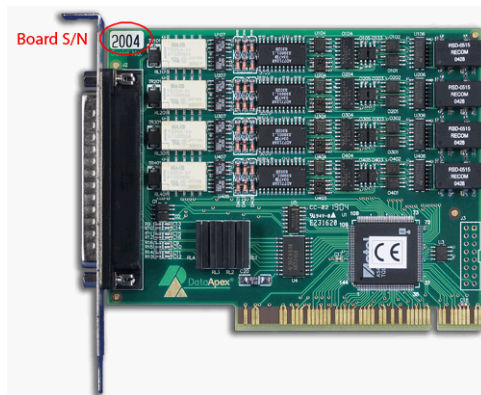

Fig. 1: INT7 A/D converter

Brief technical overview

- Up to 4 dataacquisition channels on one card (one and two channel versions are also available).
- The channels are completely independent sigma delta integrating A/D converters, used for processing positive and negative voltages.
- 4 digital inputs.
- 8 digital outputs. The first four are also designed as relay contacts.
- PCI Slot.
- Excellent reliability and temperature stability.

The **INT7** card of integration converters is a modernized successor of the PCI card INT5.

1.1 A/D Converter types in general

Prior to collecting and processing the chromatographic signal by a computer, the analog signal of the detector must first be converted to digital form using an analog/digital (A/D) converter.

In principle, there are three types of A/D converters – **sampling**, **integrating** and **$\delta\Sigma$ (Delta-Sigma)** - with continuous integration). The **INT7** card uses Delta-Sigma integration.

Advantages of the INT A/D converter

- No loss of input signal during integration. There are no time delays during which the converter fails to integrate the input signal.
- No continuous servicing of the input analog switches, which would otherwise cause errors (offset, noise).
- Substantially smaller amounts of data entering the computer due to individual data items already representing partial integrals.

2 Requirements

The **INT7** internal **PCI A/D converter** can be used with the **Clarity** software on PC's using the OS described in the **Tab. 1** on pg. **3**.

The PC must have a free **PCI** slot for your **INT7** card.

Note: Full size **PCI 2.0**, 32 bit PCI slot for 5V 32 bits half-length extension card is required. Low profile or PCI Express slots cannot be used.

Tab. 1: Hardware and Software Compatibility with supported Windows OS:

Software	Windows			
	11	10	8.1	7SP1*
Clarity	Yes (from 8.7)	Yes (from 6.2)	Yes (from 4.0.3)	Yes
Clarity Lite	Yes (from 8.7)	Yes (from 6.2)	Yes (from 4.0.3)	Yes
CSW32	No	No	No	No

* From **Clarity (Lite) 3.0** the **64-bit** OS is supported.

Tab. 2: Hardware and Software Compatibility with obsolete Windows OS:

Software	Windows		
	XpSP3*	Vista ^{SP2}	2000
Clarity	Yes (until 7.4.1)	Yes (from 3.0 to 7.2)	Yes (until 3.0)
Clarity Lite	Yes (until 7.4.1)	Yes (from 3.0 to 7.2)	Yes (until 3.0)
CSW32	Yes	No	Yes

* From **Clarity (Lite) 3.0** the **64-bit** OS is supported.

3 Installation

Ensure that you have *Administrator* access rights in your **Windows OS** before you proceed with the installation.

3.1 The INT7

- Install the **Clarity** software from the DVD-ROM.

Caution: Install **Clarity** before inputting any devices.

In Windows **2000, XP and later** the drivers were copied to your computer during the installation of the **Clarity** software.

Clar

- Turn off the **PC**.
- Plug the **INT7** card into the **PCI** slot.
- Start the **PC**.

In Windows **2000, XP and later** the drivers were installed automatically during the installation of the **Clarity** software.

- The driver is now installed, proceed to setup and wiring.
- Plug in the **HW** key (described in the **Getting Started manual**).

Note: When installing multiple **INT7** cards, a PC restart is recommended after the installation in order to prevent the reassignment of **INT7** acquisition channels between **Clarity** Instruments.

3.2 Standard cable for Clarity station

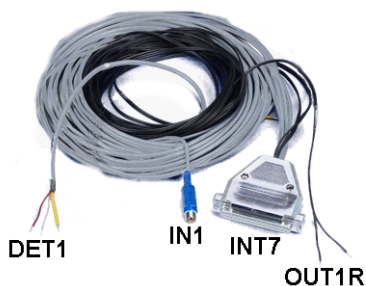

Fig. 2: Cables for the Clarity station package

The standard **Clarity** station package with **INT7** card includes a cable composed of signal and starting cables for connecting the **Clarity** station via the **INT7** card to the chromatograph. The number of signal wires, starting wires and digital output wires present corresponds to the number of signals the **INT7** card has - each signal on the card is accompanied by a set of one signal wire, one starting wire and one

digital output wire. The 2-channel **INT7** card would thus have the cable with following parts:

Signal cables

Labeled **DET1** and **DET2**, the cables are supplied as standard without connectors [bare stripped and tinned endings – red (+), white (-) and shielding (analogue ground)].

Starting (marker) cables

Labeled **IN1** and **IN2**, ended with CINCH connector (female). The following cables can be connected to this CINCH connector:

- A cable terminated with free leads [red (+), shielding (digital ground)] for direct connection to the chromatograph.
- A cable terminated with a button for cases where a starting contact is not available and it is necessary to perform a manual start.

Both types of cables are supplied for each starting cable.

Digital output cables

Relay contacts labeled **OUT1R** and **OUT2R**, terminated with free leads. These are used for synchronizing autosamplers without an **AS Control** module in the *ACTIVE* Sequence or for controlling other devices.

At the converter end the cable is always terminated with a DB-37F connector (37-pin female connector).

3.3 Connection with chromatograph

Connect the cables according to one of the following diagrams in the **Fig. 3** on pg. 6. Use the symmetrical connection only when you are sure that the chromatograph/detector is equipped with a symmetrical output – it is necessary to read through the instructions for the corresponding chromatograph.

All current **DataApex** A/D Converters **INT7**, **INT9**, **U-PAD**, **U-PAD2** and **Net-PAD** use the same standard **INT7** Connector.

Note: A description of the **INT7** connector can be found in the chapter "**Tables and specifications**" on pg. 35.

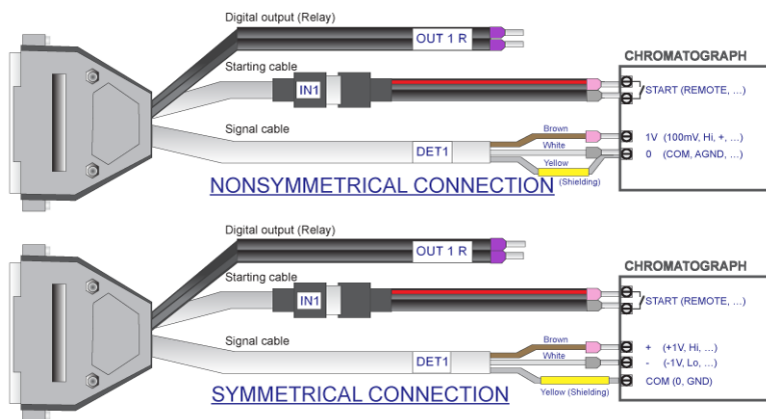

Fig. 3: Connecting Clarity to chromatograph

3.3.1 Connection of signal cables

Signal inputs of the A/D converters are symmetrical: + (red), - (white) and analogue ground (copper braiding).

Caution: Shielding must be connected. It serves not only as the shielding but also as the analogue earth against which the measurement takes place. In the case of asymmetrical output of a detector (only two connectors) shielding must be connected to the white lead! No lead of the signal cable may remain unconnected.

Try to connect to the detector output of the chromatograph with the largest possible signal level, usually indicated in the chromatograph as **INTEGRATOR** (signal approx. 1 V). The level of the signal on the output marked **RECORDER** is usually only approx. 10 mV. For easier alterations of the wiring, we supply a **SV9 Terminal board** with screw contacts for **INT7**, **INT9**, **U-PAD**, **U-PAD2** and **Net PAD** A/D converters.

Note: This **SV9 Terminal Board** is not suitable for applications with small signals or with high electromagnetic interference. This is because the **SV9 Terminal Board** uses leads and screw contacts that are not shielded.

3.3.2 Connection of starting cables

Starting input reacts to a change of the TTL level (5 V / 0 V) or to a connection by any contact (button, contact of relay).

The input implicitly reacts to a change from *HIGH* to *LOW* (contact closure). The input function may be altered by changing the *Down* option to *Up* in the *External Start/Stop* section of the *Method Setup - Measurement* dialog (accessible from the *Instrument* window using the *Method - Measurement* command).

For schemes and hints describing the typical autosampler wiring, please see the **Connecting Autosamplers** chapter of the **Getting Started Manual**.

3.4 Clarity Configuration Full version

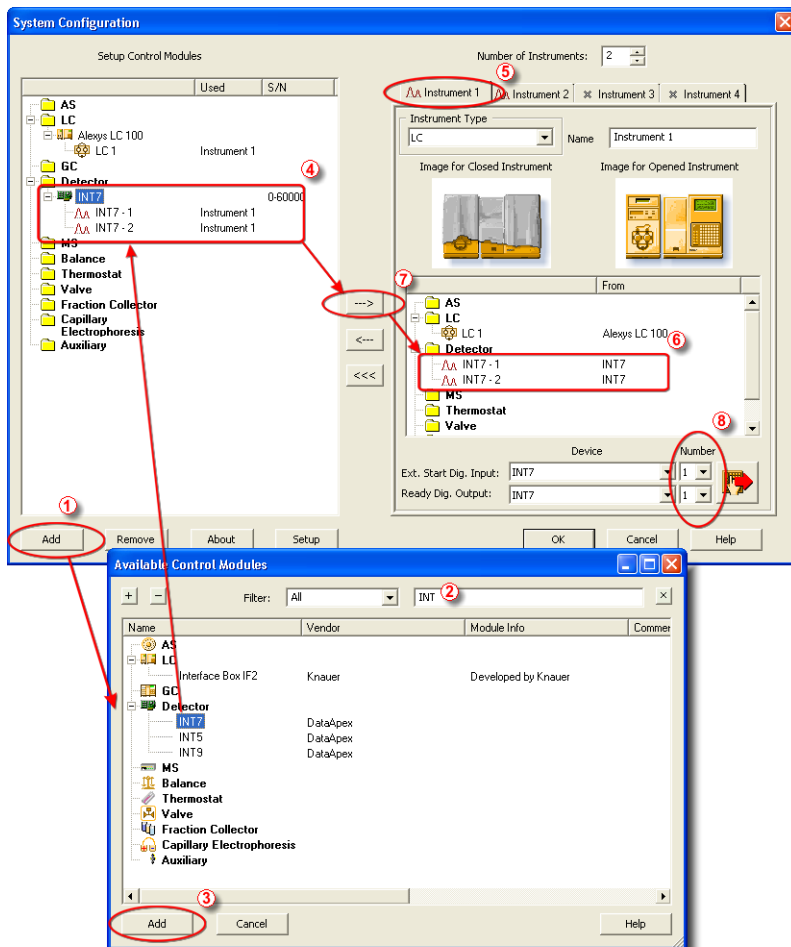



Fig. 4: System Configuration

- Start the **Clarity** station by clicking the  icon on the desktop.
- Invoke the *System Configuration* dialog accessible from the *Clarity* window using the *System – Configuration...* command.
- Press the *Add* button ① (See Fig. 4 on pg. 8.) to invoke the *Available Control Modules* dialog.
- You can specify the searching filter ② to simplify the finding of the driver.

- Select the **INT7** and press the **Add**  button.

The [DataApex INT7 Setup](#) dialog will appear.

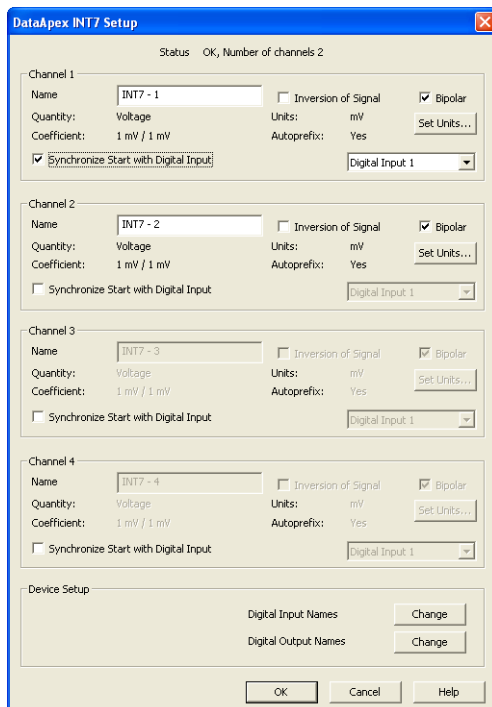







Fig. 5: DataApex INT7 Setup

- Enter the detector names in *Name* fields for individual channels, set signal units.

Note: A detailed description of this dialog can be found in the chapter "**DataApex INT7 Setup**" on pg. 12.

- Press the **OK** button.

The **INT7** will appear in the *Setup Control Modules* list  of the *System Configuration* dialog.

- Drag and drop the **INT7** icon from the *Setup Control Modules* list  on the left side of the *System Configuration* dialog to the desired *Instrument*  tab on the right side  (or use the  button  to do so).
- Set the *Ext. Start Dig. Input* and *Ready Dig. Output* numbers  for your acquisition card according to the wires being used for synchronization.

Note: The configuration dialog of the **INT7** card ([DataApex_INT7_Setup](#)) can be displayed any time by double-clicking on its icon or using the *Setup* button.

3.4.1 Measuring on Multiple Instruments

When measuring on multiple instruments using only a single **INT7** to gather data, rather than dragging the entire **INT7** icon from the *Setup Control Modules list* ①, drag the individual detector signals (**FID**, **UV-VIS** in this case) to separate Instruments ②. See **Fig. 6** on pg. 10. The Instrument to which the particular signal is connected is listed to the right ③ of the detector name in the *Setup Control Modules* section.

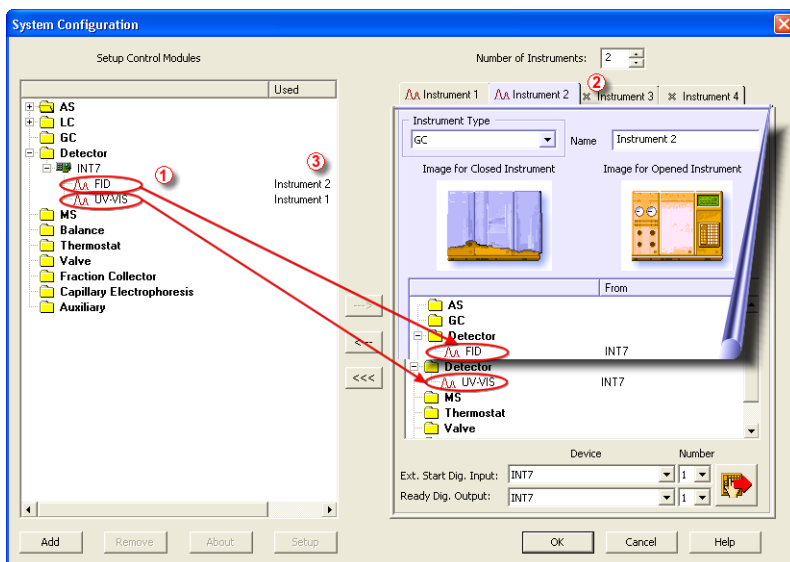

Fig. 6: System Configuration – multiple instruments

Note: Each independent **Clarity Instrument** must have separate *Ext. Start Dig. Input* and *Ready Dig. Output* pins configured according to the actual wiring.

Note: A larger number of Instruments can be set than the amount you have purchased. You will not be able to measure on the surplus Instruments (indicated by a blue symbol of the curve on the tab), but you may use them e.g. for “offline” preparation of methods.

3.4.2 Using multiple INT7 converters

When using multiple **INT7s** A/D cards, it will be necessary to add the **INT7** card again, repeating the entire procedure described in the chapter “**Clarity Configuration**” on pg. 8. from Step 3.

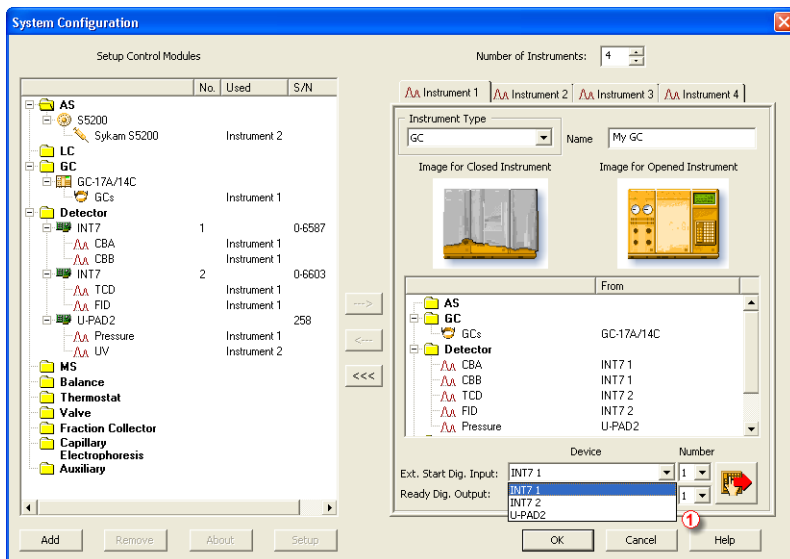

Fig. 7: System Configuration – multiple INT7s

Individual detectors from all cards can be assigned to multiple instruments and combined together arbitrarily. In this example, all signals from **INT7 A/D Card 1**, as well as all signals from **INT7 A/D Card 2** and one signal (*Pressure*) from **U-PAD2** are assigned to the *Instrument 1*, while the second signal (*UV*) from **U-PAD2** is assigned to the *Instrument 2*.

While there are several cards assigned to the same instrument, it is necessary to select which card will be used for *Ext. Start Dig. Input* and *Ready Dig. Output* signals ①.

All added A/D converters (e.g. **INT7**) must have their drivers properly installed. **Windows OS Device Manager**, otherwise you will not be able to add it in the **System Configuration** dialog and configure its detectors to Instruments.

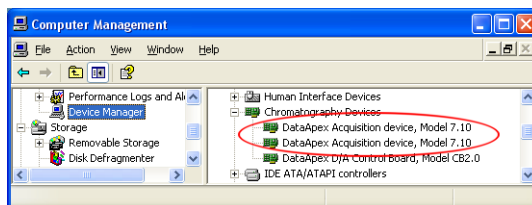

Fig. 8: Device Manager in Windows XP - two INT7 cards

Note: A maximum of **four** INT7 converters can be configured and used in **Clarity** simultaneously.

4 Using the INT7 Card

There are generally two places for setting the parameters of the **INT7 A/D Converter** in **Clarity**:

- The [DataApex INT7 Setup](#) dialog for setting the parameters that are set with respect to the type of connected signal.
- The *Method Setup - Acquisition* tab for setting the parameters related to the type of analysis.

4.1 DataApex INT7 Setup ✓ Full version

The *DataApex INT7 Setup* dialog sets the parameters of the **INT7** converter and since it depends on the type of connected detector, it is not going to be changed often.

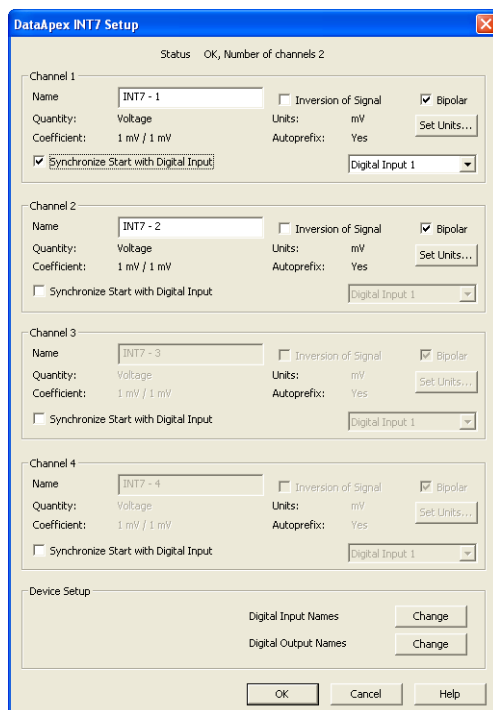

Fig. 9: DataApex INT7 Setup

Number of Channels

Indicates the number of data acquisition channels.

Channel 1 (to 4)

For each channel of the **INT7 A/D Card** the name of the signal can be edited in the *Name* field and the *Set Units...* button can be used to change other signal

parameters. Effects of these changes can be seen in other fields of the respective **Channel 1 (to 4)** section.

Note: Disabled *Channel 3 (4)* means that you have two-channel **INT7 A/D Card**.

Name

This field will be used to describe the signal in the *Chromatogram* window.

Inversion of Signal

Inverts the polarity of the signal from the detector. This function can also be used for easy correction of inversely connected wires.

Bipolar

Both positive and negative voltages will be measured. Unchecking the *Bipolar* option will improve the resolution of the signal by 1 bit. On the other hand, it will also restrict the measuring of negative signals (i.e. below zero).

Set Units...

Invokes the *Detector Units* dialog that can be used for converting the voltage measured by **INT7** to the units of the detector. Such units will then be shown throughout **Clarity** instead of default mV. Setting is specific for each **INT7** channel (signal).

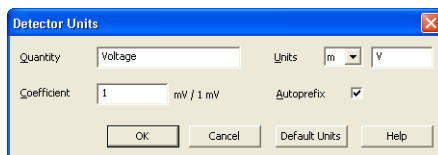

Fig. 10: *Detector Units*

- **Quantity** – Field for entering a name of the y-axis in the graph of the measured signal.
- **Units** – Field for entering the unit symbol, along with the prefix.
- **Coefficient** – Allows to enter the coefficient between the selected units and mV (default).
- **Autoprefix** – Allows to enter the unit prefix. In graphs, units will be scaled automatically, while in the tables, units with the prefix entered will be used.

Synchronize Start with Digital Input

Maps the **INT7 A/D Converter** channel to selected *External Start Digital Input*. It enables faster and more accurate synchronization of channels with the start signal. Especially for short analyses the necessary time lags at the start of the acquisition are significant. When measuring multi-detector chromatograms it will minimize the time shift between detector signals and thus improve the detection of peaks.

Note: *Synchronize Start with Digital Input* reflects the settings of the *Contact Closure/Opening* of the *External Start/Stop* option in the [Method Setup - Measurement](#) dialog.

Caution: Turn this function *ON* only in case one of the digital inputs of the configured **INT7** is also set in the *Ext. Start Dig. Input* option in the [System Configuration](#) dialog.

Device Setup

This section allows to modify the naming of digital inputs and outputs and change the Mains Supply Frequency Suppression settings.

Digital Input Names

Allows to change the names of digital inputs.

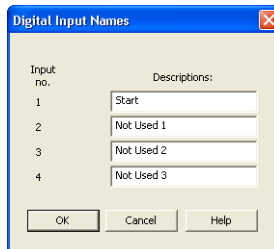

Fig. 11: Digital Input Names

Digital Output Names

Allows to change the names of digital outputs. These names will be used in the *Digital Output Control* dialog in the chapter "**Digital Inputs and Outputs**" on pg. 18.

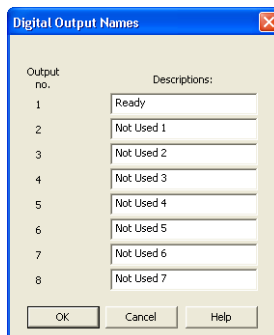

Fig. 12: Digital Output Names

4.2 Method Setup

Parameters of the *Method Setup - Acquisition* and *Method Setup - Measurement* dialogs depend on the type of analysis (measuring conditions), so they can be specific for various types of analyses. This is the reason for them to be a part of the method.

Caution: The parameters can't be changed during analysis.

4.2.1 Method Setup - Acquisition

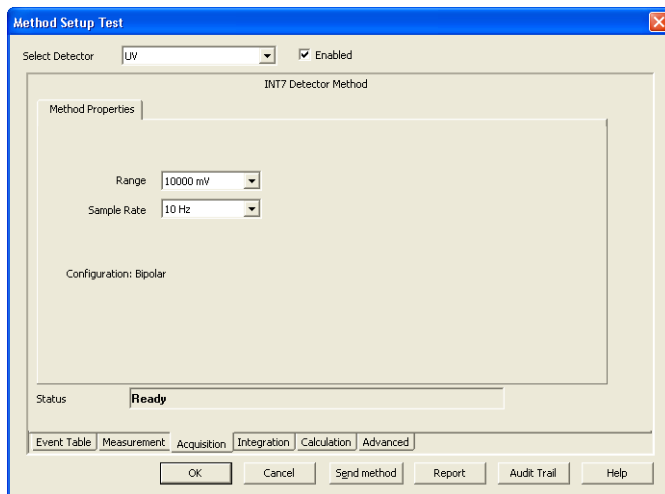

Fig. 13: Method Setup - Acquisition (INT7)

Select Detector

Selects the detector whose parameters are set. If there is only one detector (channel) configured on the **Clarity** Instrument, this control is not accessible.

Range

Selects the input voltage range (in mV). The selected range corresponds to the maximum output voltage of the detector that the A/D converter can still process. In case the detector unit conversion is set in [Detector Units](#) dialog, the range will be shown in detector units according to the conversion, while the corresponding original range in mV will be shown next to the field.

Available ranges for the **INT7** card are 156, 1 250 and 10 000 mV.

Sample Rate

Specifies the sampling rate from among 10, 25.04, 50.08, or 100.16 samples per second.

Higher sampling rate allows for the measurement of narrower peaks, but it also means a larger amount of data which affects the size of the resulting chromatogram and the speed of its processing.

Sample rate sufficient for successful peak detection is about 20 samples per narrowest peak.

A higher sampling rate also increases the amount of noise and you need to set the *Peak Width* parameter accordingly in the **Integration Table** on the *Method Setup - Integration* tab.

Note: *Range and Sampling Rate* are set individually for each detector.

4.2.2 Method Setup - Measurement

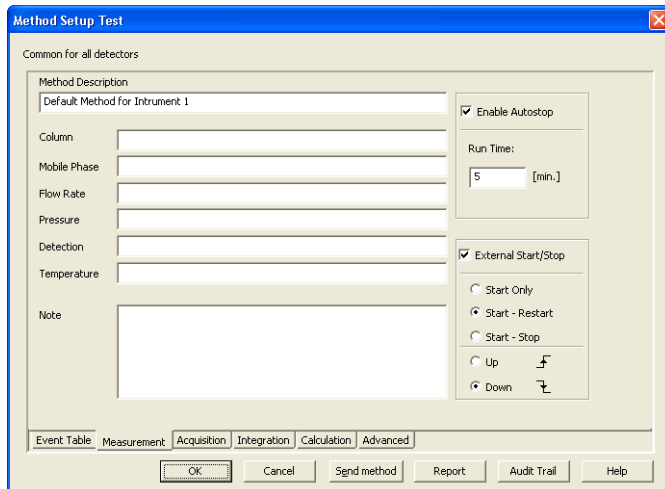

Fig. 14: Method Setup - Measurement

External Start/Stop

Enables control from an external signal.

Note: The input used for an external start from a chromatograph can be set in the *System Configuration* dialog, see **Fig. 4** on pg. 8.

Start Only

The external signal only starts an analysis. Triggering the input will not influence the acquisition in progress.

Start - Restart

The external signal terminates the analysis in progress and at the same time starts a new one. The first signal starts the analysis; the second signal terminates it and at the same time starts a new one - the so-called continuous measurement.

Start - Stop

The external signal starts and stops an analysis. The first signal starts the analysis; the second signal stops it, etc.

Down

The station reacts to changes in voltage in relevant controlling input from high (> 3 V) to low (< 0.7 V), or to contacts closed in the relay.

Up

The station reacts to changes in voltage in relevant controlling input from low (< 0.7 V) to high (> 3 V), or to contacts opened in the relay.

4.3 Digital Inputs and Outputs

The **INT7 A/D Converter** contains eight **digital TTL outputs**, where the first four are also designed as relay contacts. The converter contains four **digital inputs** IN1 - IN4. The first two inputs are also equipped with optocouplers.

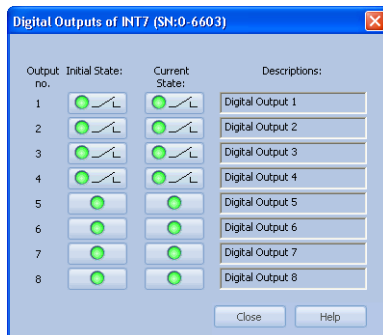

Fig. 15: Digital Outputs of INT7

These outputs can be controlled from the following places in **Clarity**:

- Standard assignment of external *Ext. Start Dig. Input* and *Ready Dig. Output* can be changed in the [System Configuration](#) dialog - ⑧ in the **Fig. 4** on pg. 8.

Note: The assigned input and output is then automatically used in the *ACTIVE* sequence for synchronization with the autosampler.

- *Digital outputs of INT7* dialog.
- [Device Monitor](#) of the **INT7**.
- In the *Method Setup - Event Table* dialog.

4.4 Device Monitor

The *Device Monitor* window can be invoked by the *Monitor - Device Monitor* command from the *Instrument* window or using the **Device Monitor**  icon. It displays the states of digital inputs and enables the user to monitor and change the states of digital outputs.

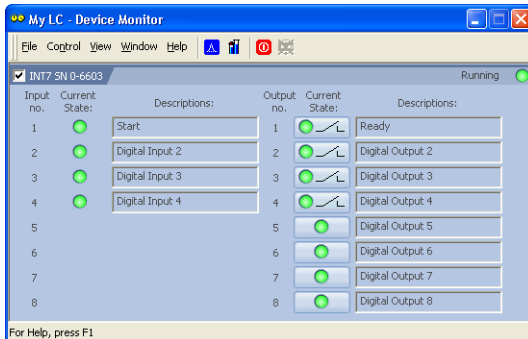

Fig. 16: Device Monitor - INT7

Input no.

Lists the numbers of individual inputs.

Current State

Indicates the current status of the particular input. Green light corresponds to logical one (*HIGH*), light switched off (gray icon) to logical zero (*LOW*).

Descriptions

Shows the description indicating the meaning of individual input. The names of all digital inputs can be set in the [DataApex INT7 Setup](#) dialog.

Output no.

Lists the serial numbers of individual outputs.

Current State

Indicates the current status of the particular output which also works as relays. Green light corresponds to logical one (*HIGH*), light switched off (gray icon) to logical zero (*LOW*). The state of any output can be changed by clicking on the *Current State* button of the particular output.

Descriptions

Shows the description indicating the meaning of individual output. The names of all digital outputs can be set in the [DataApex INT7 Setup](#) dialog.

5 Troubleshooting

If you will not find your answers here, use the www.dataapex.com website where the Support menu will navigate you to frequently asked questions (FAQ), **Clarity** email conference archive or contact to **DataApex** helpdesk.

5.1 Locate your problem

When troubles occur, the fastest way to find a solution for it is to search for it in the following index via the **Dialog** (window), in which the problem occurred, **Error Messages** that appear or according to utilized **Hardware**. The name of the window/dialog is visible in its header.

Note: Names of individual **Clarity Instruments** appear in the header instead of the common term "Instrument".

List of windows and dialogs

Dialogs	
Clarity	pg. 32.
Data Acquisition	pg. 34.
Instrument	pg. 32.
Method Setup	pg. 32.
Sequence	pg. 32.
Single Analysis	pg. 32.
System Configuration	pg. 21., pg. 32., pg. 34.

List of Error Messages

Error Messages	
Board malfunction	pg. 21.
Cannot create detector	pg. 21.
Cannot find driver file ...	pg. 21.
Cannot find first board	pg. 21.
Cannot find second board	pg. 21.
Disabled (in the status line)	pg. 32.
Error Occurred During Setup	pg. 21.
Simulated (in Data Acquisition)	pg. 34.

Note: To find solutions for error messages not listed above, check the **Clarity Getting Started** Guide or visit our web pages www.dataapex.com.

5.2 Problems with INT7

“Board malfunction” error message appears.

Description: The card is probably incorrectly inserted or damaged.

Solution: Check whether the **INT7** A/D card is correctly set in the **PCI** slot. The card should be tucked fully and should not move in the slot. If this does not help, contact technical support to replace the damaged card.

Most problems with INT7 driver are generally indicated by following symptoms:

- **INT7** cannot be added to *Setup Control Modules* in the *System Configuration* dialog, showing the "Cannot create detector" error message.
- Double-clicking on the device will not invoke the [DataApex INT7 Setup](#) dialog.
- The **Data Acquisition** icon in the *Instrument* window is not active (this problem may also have another cause. For more details see the chapter **Data Acquisition - non-functional** on pg. 32).
- When starting **Clarity** or trying to add more **INT7** cards to configuration then is present in the PC, the error message "**Cannot find first board**" appears. Alternatively, "**Cannot find second board**" error message may appear.
- While trying to add the **INT7** card in the *System Configuration* dialog or while starting **Clarity**, "**Cannot find driver file ...**" error message with path to the **INT7** drivers in the system followed by "**Error Occurred During Setup**" appeared.

Solution: When one of these problems occur, check the **INT7** driver (see the chapter "**How to check the INT7 driver**" on pg. 22.) and then proceed according to the suggested solutions.

5.2.1 How to check the INT7 driver

Windows XP/2000

In the lower left corner of the screen, in the *Start* menu, select *Settings - Control Panel* and the *System* icon, and under the *Hardware* tab click on the *Device Manager* button.

Windows 10/7/Vista

In the lower left corner of the screen, in the *Start* menu, type "Device Manager" in the search field and click on the found item.

Windows 8.1

Press the *Windows* key on your keyboard and start typing "Device Manager", in the results, click on the found item.

In the desired *Device Manager* window look up the resulting list for item "**Chromatography Devices - DataApex Acquisition Device Model 7.xx**".

In the following image, all drivers (except the **U-PAD 2.0** driver) are installed correctly.

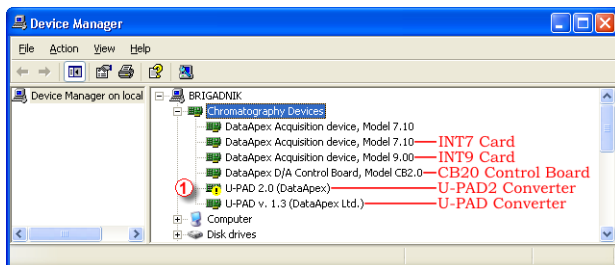

Fig. 17: Device Manager in Windows XP

Error status of the driver may be one of the following:

If the "Chromatography Devices – DataApex Acquisition Device Model 7.xx" - item does not appear, then the driver has not been installed.

Solution: Reinstall the driver manually as described in the chapter "**Installation and reinstallation in Windows XP and later**" on pg. 24.

The driver is installed, but there is a yellow exclamation mark (⚠ in the Fig. 17 on pg. 22.) or a question mark over its icon, or it is not behaving as expected. The driver is probably installed incorrectly.

Solution: Reinstall the driver manually as described in the chapter "**Installation and reinstallation in Windows XP and later**" on pg. 24.

The item does appear, but is displayed with a cross symbol.

Solution: Double-click the item to invoke the *General* tab and activate the driver by clicking on the *Enable this device* button.

The item does appear and there are no error symbols around it. A driver for a different type of Windows operating system was possibly installed thereby replacing the correct driver.

Solution: Uninstall the incorrect driver and install the correct one as described in the chapter "**Installation and reinstallation in Windows XP and later**" on pg. 24.

5.3 Manual Installation

5.3.1 Installation and reinstallation in Windows XP and later

- During start-up, **Windows** should automatically recognize the new **Plug and Play** device and start the *Add Hardware Wizard*.

Note: If the wizard does not occur, use the *Start - Control Panel – Add Hardware* to invoke installation.



Fig. 18: Step 1 of Hardware Installation Wizard

- Click the *Next* button.



Fig. 19: Step 2 of Hardware Installation Wizard

- Select *No, not this time* and click *Next*.

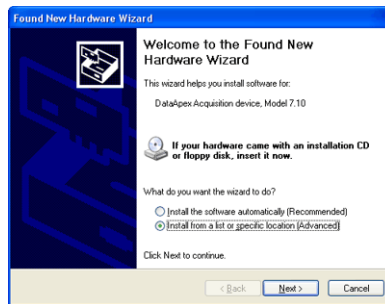

Fig. 20: Step 3 of Hardware Installation Wizard

- Select the *Install from a list or specific location (Advanced)* option and click *Next*.

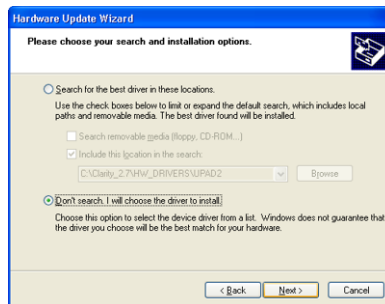

Fig. 21: Step 4 of Hardware Installation Wizard

- Select *Don't search. I will choose the driver to install.* and click the *Next* button.

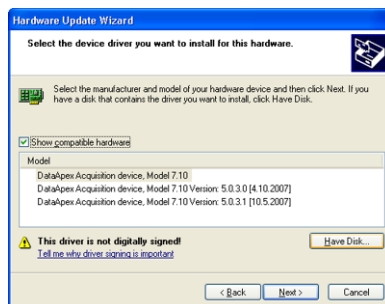

Fig. 22: Step 5 of Hardware Installation Wizard

- To be sure that Windows install the correct driver, click the *Have Disk...* button.

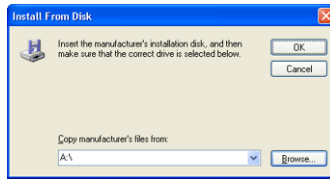

Fig. 23: Step 6 of Hardware Installation Wizard

- Click the *Browse...* button and in the displayed *Locate File* dialog browse to the main folder of the **Clarity** Station and HW_DRIVERS\INT7 subfolder (C:\CLARITY\HW_DRIVERS\INT7 by default). Select the CSWINT7.INF file and click the *Open* button. Now you are back in the *Install From Disk* dialog displaying the correct path to the CSWINT7.INF file. Click the *OK* button.

Note: The driver is also located on the **Clarity** installation DVD-ROM in the HW_DRIVERS\INT7 subfolder.

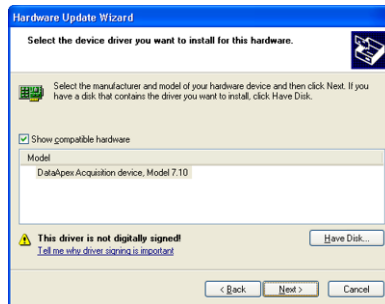

Fig. 24: Step 7 of Hardware Installation Wizard

- Now the *Hardware Update Wizard* shows the correct driver to be installed in **Windows**. Click the *Next* button and after completing the installation click the *Finish* button in the following dialog.

5.3.2 Reinstallation of drivers using the System Restore Point

Use the **System Restore Point** in **MS Windows XP** and later to uninstall the incorrect drivers.

- Go to *Start – Programs – Accessories – System Tools – System Restore* in **Windows XP** or press the *Windows* key on your keyboard and type "System Restore" in the search field and click on the found item in **Windows Vista/7/8.1/10**.
- In the *System Restore* dialog use the *Restore my computer to an earlier time* in **Windows XP** or *Choose a different restore point* in **Vista/7/8.1/10** option and press the *Next* button.
- In the next dialog select a restore point from a time before the incorrect driver was installed.

Caution: Any software or hardware that was installed after the moment of the selected restore point will be removed from your system.

- Reinstall **Clarity** and then restart the PC.
- **Windows** should now correctly identify and install the drivers.

5.3.3 Reinstallation of drivers in Windows 2000

Note: Windows 2000 is supported until **Clarity** version 3.0 only.

After installing **Clarity** and the **INT7** device, the *Device Manager* either does not display the *Chromatography Devices – INT7* item at all or it displays a yellow exclamation mark next to the item that indicates that the device is not working properly.

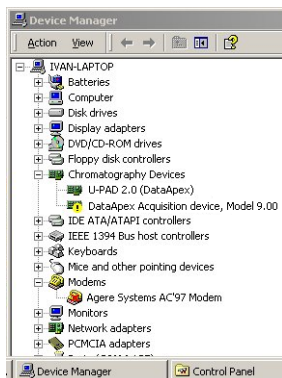

Fig. 25: Device Manager in Windows 2000

If the "**DataApex Acquisition device, model 7.XX**" item is missing, Windows has automatically installed incorrect driver.

If you are able to locate which device was mistakenly installed instead of the **INT7** driver, you can open its *Properties* and *Update this driver*. In the manual installation process, select the correct drivers analogously to the description in the chapter "**Installing the correct driver manually**" on pg. 29.

If the correct driver cannot be determined, the last installed driver will have to be removed.

Caution: This procedure can be used safely only if you did not install any other hardware since the installation of the converter.

5.3.3.1 Deleting incorrect *.INF files in the system

Note: Be sure to have the **Clarity** software installed already.

- Open the C:\WINNT\INF (C:\WINDOWS\INF) folder  in *Windows Explorer*.

Note: You may have to allow for the hidden system files to be displayed. In menu select *Tools – Folder Options -> View* tab then set the *Hidden Files and Folders* option to *Show Hidden Files and Folders*.

- Sort the files according to *Modified* column ② and locate the last modified *.PNF file ③ .
- Also locate the corresponding *.INF file ③ and delete both of them.

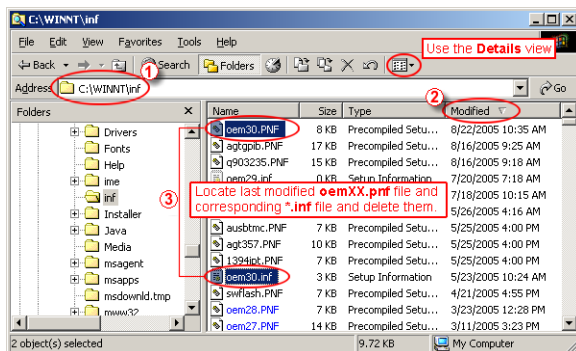

Fig. 26: Windows Explorer

- Continue to install the correct driver manually (described in the chapter "Installing the correct driver manually" on pg. 29.) without restarting the PC.

5.3.3.2 Installing the correct driver manually

The following procedure described step by step can be applied under any circumstances.

- Invoke the *Start – Control Panel – Add/Remove Hardware*
- In the first dialog click the *Next* button.

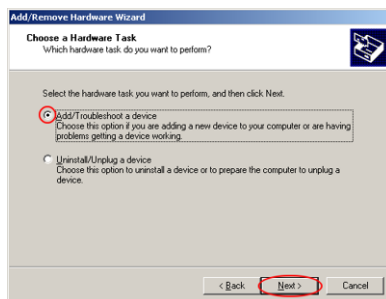

Fig. 27: Step 1 of Add/Remove Hardware Wizard

- Select *Add/Troubleshoot a device* and click the *Next* button.

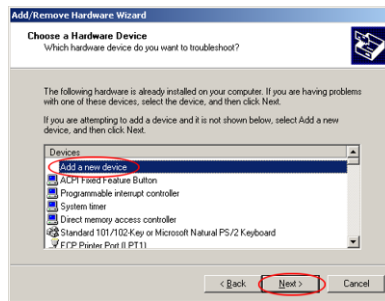

Fig. 28: Step 2 of Add/Remove Hardware Wizard

- In the **Devices** list select the *Add a new device* and click the *Next* button.

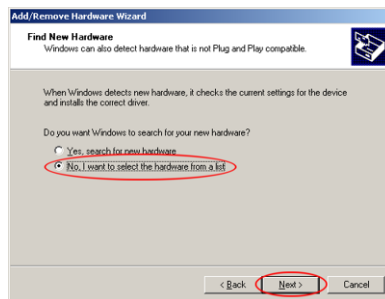

Fig. 29: Step 3 of Add/Remove Hardware Wizard

- Select *No, I want to select the hardware from a list* and click the *Next* button.

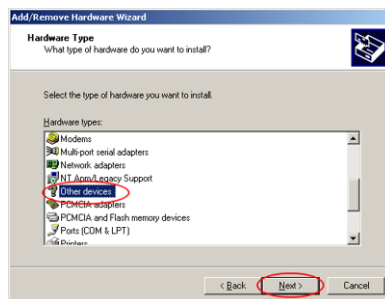

Fig. 30: Step 4 of Add/Remove Hardware Wizard

- In the **Hardware types** list select the *Other devices* option and press the *Next* button.

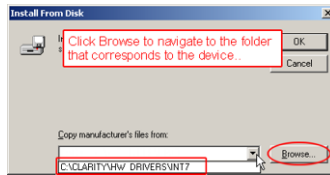

Fig. 31: Step 5 of Add/Remove Hardware Wizard

- Set the path to the correct drivers. These drivers can be found in the directory where **Clarity** is installed (C:\CLARITY\BIN by default), in the HW_DRIVERS\INT7 subfolder. Then click the OK button.

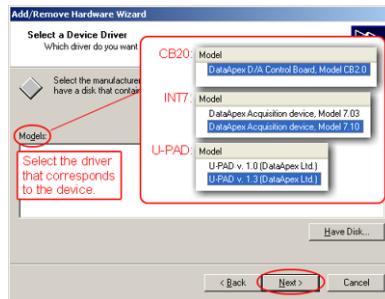



Fig. 32: Step 6 of Add/Remove Hardware Wizard

- In the *Models* list select the **"DataApex Acquisition device, Model 7.XX"** and click the *Next* button.
- In the remaining dialogs press the *Next* button.
- Restart the PC.
- Re-check the driver in the *Device Manager* as described in the chapter **"Reinstallation of drivers in Windows 2000"** on pg. 28.

5.4 Data Acquisition - non-functional

Gray  icon with the heading **DISABLED** and non-functional **Monitor - Data Acquisition** command.

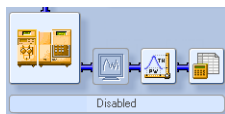

Fig. 33: Data Acquisition disabled

Other manifestations of this error are also: [Method Setup - Acquisition](#) tab missing, *Method - Acquisition* command non-functional, *Run*, *Stop*, *Abort* and other similar commands non-functional in the *Single Analysis*, *Sequence* or *Device Monitor* windows. Possible causes are:

Description: a) You are using **Clarity Offline** or a **Clarity DEMO** version, which does not enable the measurement of chromatograms.



Fig. 34: Clarity Offline and Clarity DEMO

Solution: Check whether there is a blue line with the title **OFFLINE** displayed in the main **Clarity** window under the symbols of the Instruments, or the title **DEMO** in the **Clarity** window header.

In case of **Clarity DEMO**, use the **Windows Start** menu to locate the **Clarity DEMO** group in the *All Programs* section and select the *Remove Clarity* item there.

Then, use the correct **Clarity** installation DVD to install the full version.

In case of the **Clarity Offline** station, remove the HW key with the **Offline** license and insert key with the **Clarity** full licence.

Description: b) Detector is not allocated to the **Clarity** Instrument:

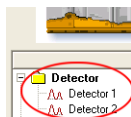

Fig. 35: Detector not allocated to the Instrument

Solution: Open the **System Configuration** dialog from the **Clarity** window using the *System - Configuration...* command and check the tab of the corresponding Instrument - **Instrument X**. If it has no allocated detectors, add them.

In the left-hand list *Setup Control Modules* select the correct detector connected to the **A/D card** you are using and drag it to the corresponding instrument on the right.

If your **A/D card** is not in the left-hand list *Setup Control Modules*, add it using the *Add* button and repeat the previous step.

Note: More information on the *System Configuration* dialog can be found in the chapter "**Clarity Configuration**" on pg. 8.

Description: c) You have a licence purchased for data collection from a smaller number of Instruments:

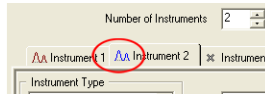

Fig. 36: Small number of Instruments purchased

Open the *System Configuration* dialog from the *Clarity* window using the *System - Configuration...* command and check the tab of the corresponding Instrument - **Instrument X**. Blue symbol of the curve in the tab header indicates that Instrument is not usable for measuring.

Solution: Check your serial number S/N for example using the command *Help - About...* from the main *Clarity* window.

5.5 Data Acquisition - Simulated

The title "Simulated" is displayed in the *Data Acquisition* window.

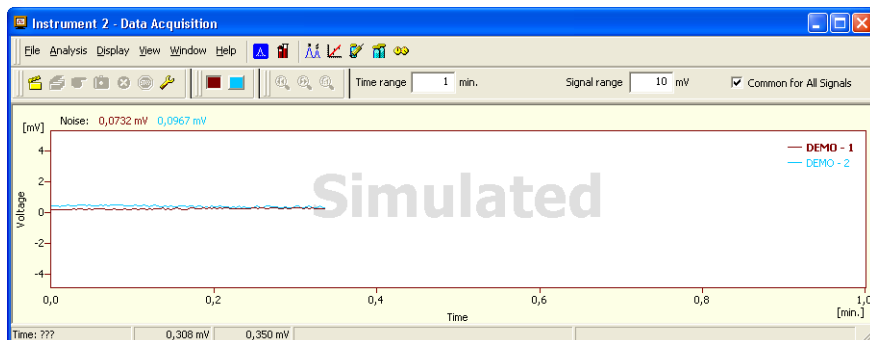

Fig. 37: Data Acquisition Simulated

Description: The corresponding Instrument only displays the simulated curve (from the file CHANNX.DTA file) in the *Data Acquisition* window, or in other words has allocated a **DEMO detector** on itself.

Solution: Open the *System Configuration* dialog from the *Clarity* window using the *System - Configuration...* command and check the tab of the corresponding Instrument - **Instrument X**. If it only has the detector signals from the **DataApex DEMO** detector, it is necessary to reconfigure it. You can find more information how to add a detector in the chapter "**Clarity Configuration**" on pg. 8..

Make sure that you have installed a full version of **Clarity**. If this is not the case, inscription *DEMO* is in the header of the main window. If so, install the full version and enter the user code you have been provided. Also make sure that the detector is properly configured.

6 Tables and specifications

6.1 Description of the INT7 connector (Male)

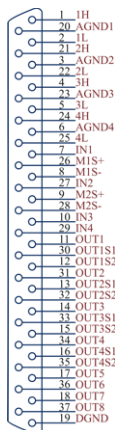

Fig. 38: Connector pins

Tab. 3: Description of the connector pins:

Pin	Description
1H	+ Input of the 1st channel
1L	- Input of the 1st channel
AGND	Ground of the analog channels
IN1	Digital input (of the 1st channel). Used as an External Start (marker) of the 1st channel.
OUT1	1st Digital output. Digital outputs are controlled by <i>Event Table</i> , <i>ACTIVE</i> sequence and Digital outputs of INT7 dialog.
DGND	Ground of the digital inputs and outputs.
M1S+	+ pin of the 1st Digital input. Level is <i>LOW</i> when current flows between M1S+ and M1S-.
M1S-	- pin of the 1st Digital input.
OUT1S1 OUT1S2	Digital outputs - 1st relay contact. Contact is closed when output is at a <i>LOW</i> level.

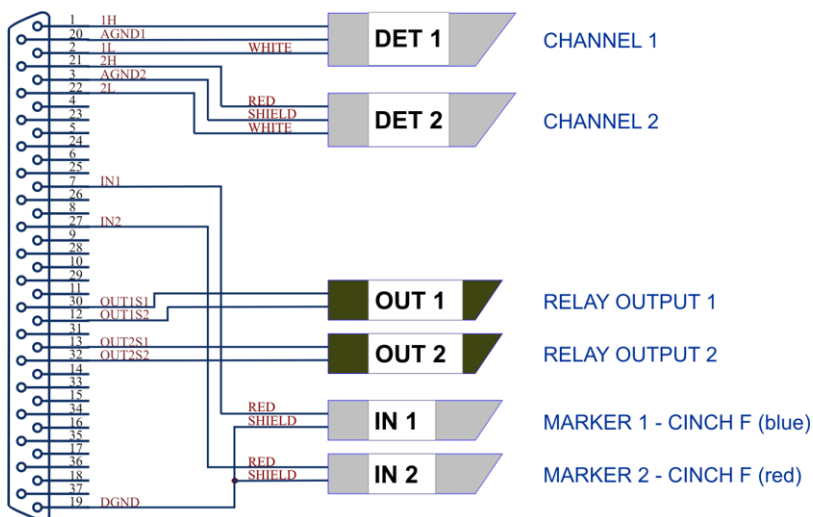

Fig. 39: Standard INT7-compatible cable for two detectors

6.2 Parameters of Digital Inputs and Outputs

Digital Outputs

The card contains eight digital TTL outputs (OUT1-OUT8) with a maximum permissible current of 20 mA at both levels. The first four outputs are also equipped with relay contacts (OUT1S1/OUT1S2- OUT4S1/OUT4S2).

The maximum permissible current is 100 mA , the maximum-switched voltage is 100 V and the contact resistance is $150\text{ m}\Omega$. The relay is onstate (closed) when there is a *LOW* level of a relevant digital output.

Digital Inputs

The card contains 4 digital TTL inputs IN1 to IN4. The first two inputs are also equipped with an optoelectronic isolator (M1S+/M1S- and M2S+/M2S-). The excitation current is 5 mA and corresponds to input level *LOW*.

The LED of the isolator is directly connected to the connector.

Caution: A resistor must be inserted (e.g. in the connector) to restrict the diode current to 10 mA max.

To suppress the contact bouncing, the digital inputs are equipped with monostable toggles that prolong any change affecting the input to at least 200 ms (to ensure that the station is able to detect it).

A pulse with duration of at least 1 ms is necessary in order to excite the toggles.

6.3 INT7 - CE Conformity Declaration

CE CONFORMITY DECLARATION

We, **DataApex Ltd.**

Podohradská 1704/1

CZ - 155 00 Prague 5

declare under our sole responsibility that

the product:

chromatography integrator

type:

INT7

to which this declaration relates is in conformity with the following standards

CISPR 22 2005+A1:2005

CISPR 24 1997+A1+A2:2002

Complementary information: Certificate EZÚ no.: 502594-01/01 dated 16.8.2005

Place of issue: **Prague**

Manufacturer representative: **L. Siska**



Date of issue: **5.12.2005**

Position: **hardware production manager**

Fig. 40: CE Conformity declaration - INT7

pa

6.4 Technical data

Tab. 4: Technical data of the INT7 board:

Parameter	Description
Converter type:	24-bit $\delta\Sigma$ (delta – sigma)
Analog inputs:	differential
Number of channels:	1, 2 or 4 fully independent and isolated
Input range:	unipolar and bipolar, each channel independently 156, 1 250 or 10 000 mV
Input impedance:	> 10 M Ω
Sample rate:	10, 25.04, 50.08, 100.16 Hz
Non-linearity:	< 0.003 %
Temperature dependence	< 10 ppm/°C
Digital inputs:	4 TTL (5 V), first two can be also controlled using the built-in optocouplers (5 mA current)
Digital outputs:	8 TTL (5 V, maximum current load per output 20 mA, maximum total current load 100 mA), the first four control relays (switching contacts rating: max. switching current 0.5 ADC, max. contact resistance 150 m Ω , max. voltage 100 V)

Tab. 5: Typical noise free resolution for various acquisition speeds and input ranges:

	10 V	1 250 mV	156 mV
10 Hz	20 bit	19 bit	16 bit
50 Hz	18 bit	17 bit	15 bit
100 Hz	17 bit	15 bit	14 bit